

GSM/GPRS/GPS TRACKER USER MANUAL

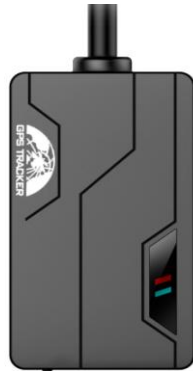

Preface

Thank you for purchasing the tracker. This manual shows how to operate the device smoothly and correctly. Make sure to read this manual carefully before using this product. Please note that specification and information are subject to changes without prior notice in this manual. Any change will be integrated in the latest release. The manufacturer assumes no responsibility for any errors or omissions in this document.

Contents

1.	Hardware Description	4
2.	Accessory.....	4
3.	Specs	6
4.	Instructions for web platform and mobile APP	6
5.	Installation	10
5.1	Terminal installation.....	10
5.2	SIM card installation and turn on the device	10
5.3	GSM/GPS LED Indicator	11
6.	Function introduction.....	11
6.1	Initialization	11
6.2	Change Password.....	11
6.3	Authorization	12
6.4	Single Locating.....	12
6.5	Auto track continuously	13
6.5.1	Track with limited times upon time interval	13
6.5.2	Track with unlimited times upon time interval	13
6.5.3	Track upon distance interval.....	13
6.5.4	Smart track upon time and distance interval	13
6.6	Data logging and upload	14
6.7	Exact street address	14
6.8	Forward the third parties' message.....	14
6.9	SIM card Balance Inquiry	15
6.10	ACC working alarm	15
6.11	Cut off the Oil and Power System (For B,C model))	15
6.12	Remote controller (For C model).....	16
6.13	Set up arm/disarm by SMS.....	17
6.14	Decide how many times of alarm message.....	17
6.15	Alarms	17
6.15.1	Low battery alarm	17
6.15.2	Power off alarm.....	18
6.15.3	Geo-fence	18
6.15.4	Movement alarm	18
6.15.5	Over speed alarm.....	18
6.15.6	ACC Alarm.....	19
6.15.7	Built in Acceleration Sensor Alarm	19
6.16	Sleep Mode	19
6.16.1	Always online	19
6.16.2	Sleep Mode.....	19
6.17	Check the Vehicle State.....	20
6.18	Check IMEI.....	20
6.19	Terminal (local) Time Setting	20
6.20	GPRS settings	20

6.20.1	Configure APN.....	21
6.20.2	Configure user, password for GPRS login.....	21
6.20.3	Configure IP and port	21
6.20.4	Switch to GPRS mode	21
6.21	Configure parameters by USB.....	22
7.	Cautions	22
8.	Faults & the Solutions.....	22

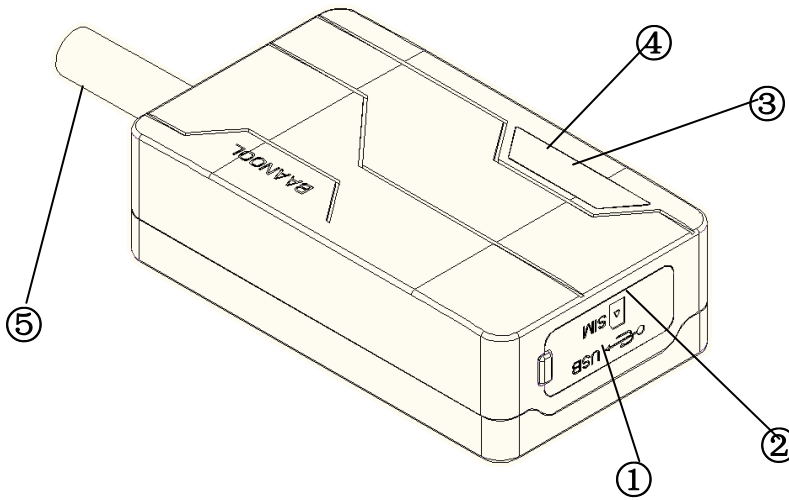

1. Hardware Description





① USB port ②SIM card slot ③GSM indicator ④GPS indicator ⑤ Harness

Model Version	A Model (Basic track model)	B Model (Engine control model)	C Model(The model with a remote control)
H Version (High voltage version, 8~80V)	Basic track	Add engine stop function on the basis of model A	Add engine stop function and a remote control on the basis of model B
L Version (Low voltage version 8~40V)			

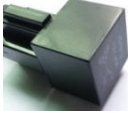
2. Accessory

Picture	Name	Specs	Applicable model
	Harness	3PIN	Standard for model A
	Harness	5PIN	Standard for model B/C
	Relay	12V/40A or 24V/40A	Standard for model B,C

	Siren	24V/48V	Optional for model C
	Remote control	433MHz	Optional for model C

3. Specs

Content	Specs	
DIM.	6.0×3.5×1.8cm	
Weight	50g	
Network	GSM/GPRS	
Band frequency	850/900/1800/1900Mhz	
GPS sensitivity	-165dBm	
GPS accuracy	5m	
GPS start time	Cold status 45s Warm status 35s Hot status 1s	
H version (High voltage version)	High voltage version	8V - 80V
L version (Low voltage version)	Low voltage version	8V - 40V
Back up battery	Chargeable 3.7V 180mAh Li-ion battery	
Storage Temp	-40°C to +85°C	
Operation Temp.	-20°C to +65°C	
Waterproof grade	IP67	

4. Instructions for web platform and mobile APP

Users need to register an account on www.gpstrackerxy.com before use web platform or mobile App, account name and password is the same on web platform and mobile App.

4.1. Register an account



4.2. Login

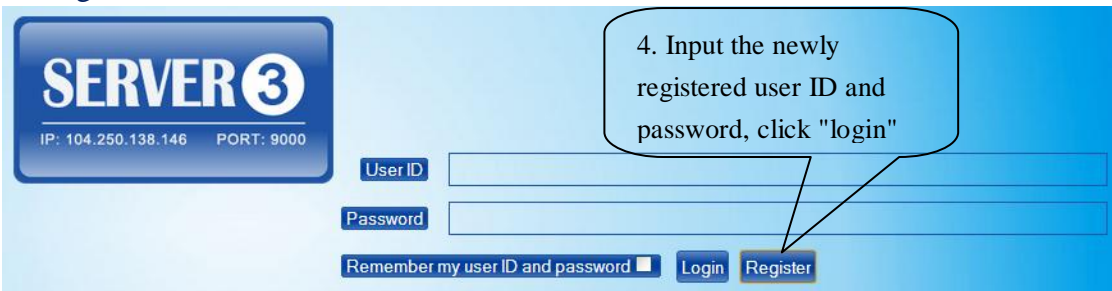

4.3. Add a terminal

TrackerHome

Terminal List Terminal Control Route Repeat Manual Track Reports System Settings Notice Quit System

Terminal Name Demo [IMEI: 0000000000000000] Terminal Management 2:31

- Group Management
- Account Management
- Change Password

5. add terminal

Name	Date & Time	Description	Speed	Altitude	Oil1	Oil2	°C	ACC	Door	LBS	Latitude	Longitude
Demo	2015-04-16 08:27:01	Position info	0km/h	0.0m	0.0%	0.0%	0	Off	Close	No	22.586680	113.907718
Demo	2015-04-16 08:26:56	Geo fence had been clear.	0km/h	0.0m	0.0%	0.0%	0	Off	Close	No	22.586225	113.907945
Demo	2015-04-16 08:20:56	Position info	0km/h	0.0m	0.0%	0.0%	0	Off	Close	No	22.586225	113.907945
Demo	2015-04-16 08:20:37	Position info	0km/h	0.0m	0.0%	0.0%	0	Off	Close	No	22.586225	113.907945

5. add terminal

Expiry Date From 1900-01-01 To 9998-12-31 IMEI NO. Keyword: Search Add Delete Quit

IMEI NO.	Name	Icon	Model	Group Name	Expiry Date
		Car	All Functions		

7. enter IMEI

8. Device

9. Choose icon

10. Save

Terminal List Terminal Control

Terminal List

(Online:0 Offline:1)

demo

11. The newly registered device is offline in grey color

4.4. Configure your tracker to web platform to track it online

Step 1: Set APN, refer to 6.20.1

Step 2: Set GPRS user name and password, refer to 6.20.2

Step 3: Set IP and port, please use the corresponding IP and port of the server you choose, Refer to 6.20.3

Step 4: Switch to GPRS mode, refer to 6.20.4

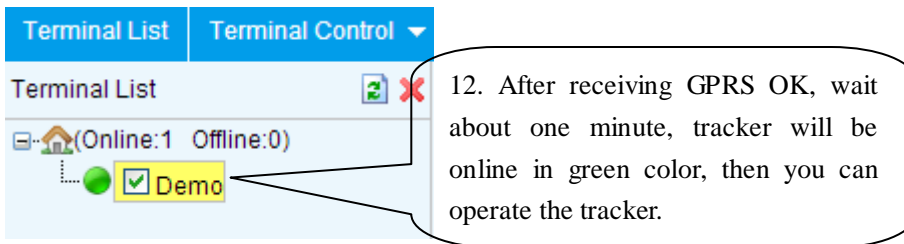

4.5. If the tracker is always offline (grey color), make sure the SIM card subscribe the GPRS service, and the credit is enough to surf the Internet, you can use phone to test if the SIM card can surf the Internet.

Besides, please check the APN, user name, password, IP, port settings are correct, refer to 6.17.

4.6. IOS & Android mobile APP

4.6.1. Download and install the mobile application.

According to your phone type, download and install mobile app below the home page on web tracking platform.



4.6.1.1. Login and use the GPRS version

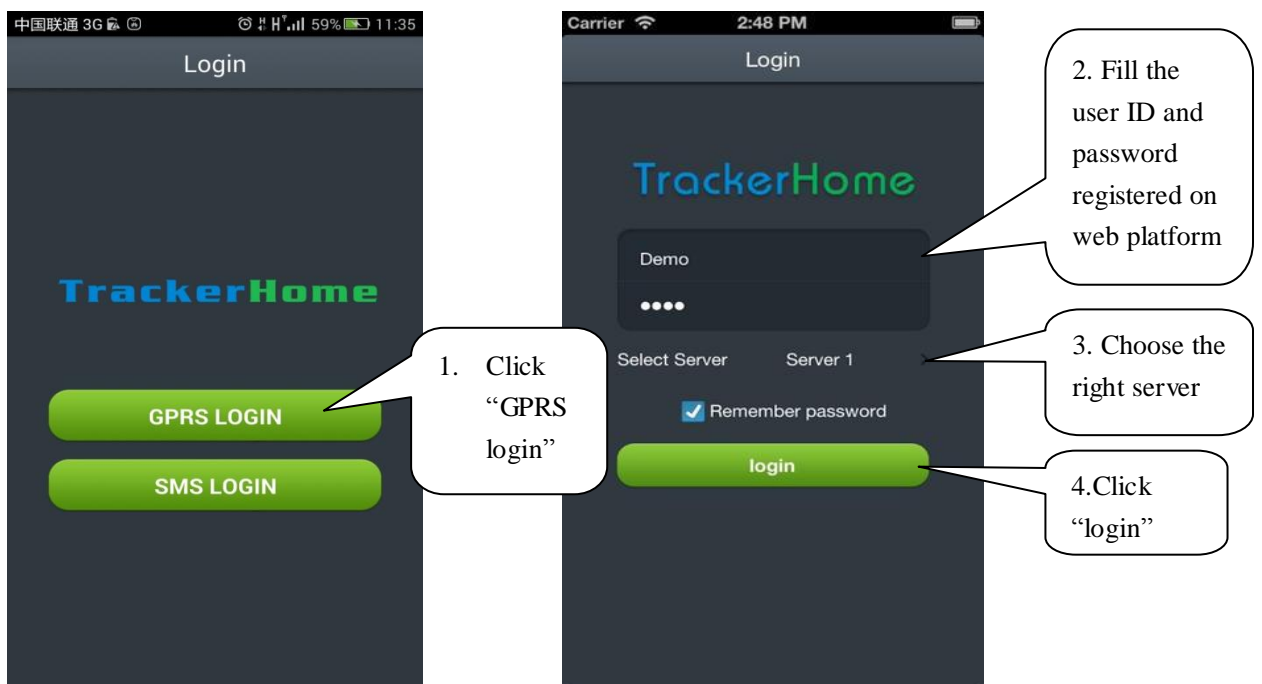



5. Installation

5.1 Terminal installation

- Please ask the qualified engineers to install it.
- Do not install it in an environment which is over GSM performance index.
- Pay attention to make installation location preventing water and dust.
- Find the harness in the package and insert it into the corresponding holes of the products, and connect the wires with the original car circuit showing below:

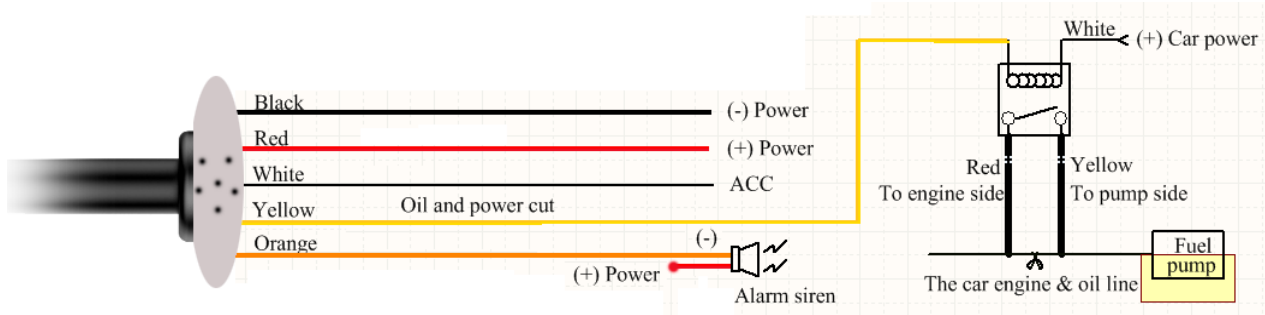

Wiring diagram

- The orange wire can be connected to the original car horn; it can also be connected to the siren bought with the tracker.

5.2 SIM card installation and turn on the device

Note: Please make sure the SIM card is for GSM network and able to execute the

function of incoming calls display, no calls can be diverted and the PIN code is locked. The SMS format must be TXT format, device can't recognize the PDU format. Proposed data flow package no less than 30MB per month.

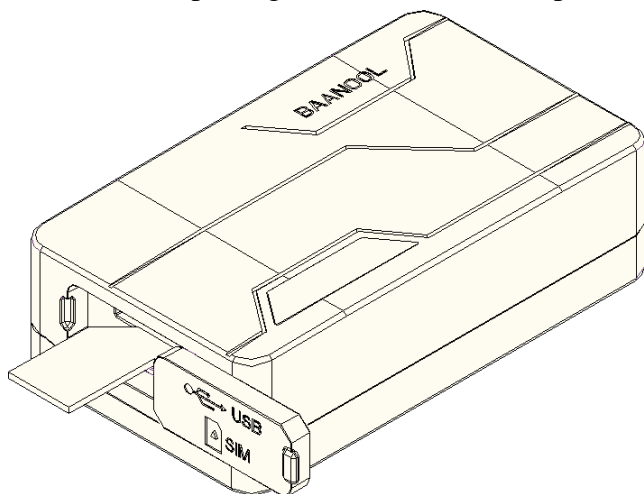

- ❶ Open sealed buckle
- ❷ Insert the SIM card, the device will turn on automatically.
- ❸ Put sealed buckle back.

When use the device at first time, take the device at outdoor, the device will find GSM and GPS signal and work normally after 10-40 seconds. Under normal conditions, the indicator light of the device flashes once every 3 seconds.

5.3 GSM/GPS LED Indicator

Green LED: In GSM Mode, LED flash once for each second, In GPRS Mode, LED flash one time in three seconds, when No GSM reception, LED keep ON.

Blue LED: In good GPS reception, LED quick flash for each second, No GPS reception, LED OFF.

6. Function introduction

6.1 Initialization

Send SMS “begin+password” to the unit, it will reply “begin ok” and initialize all the settings to default factory settings. (default password: 123456)

For example: send SMS “begin123456”, it will reply “begin ok”. (No quotation marks“” when sending all the SMS)

6.2 Change Password

6.2.1 Send SMS “ password+old password+space+new password” to the unit to change the password.

For example: send SMS “password123456 888888” to the unit. If succeeded, “password ok”

will reply to your cell phone from the device tracker. Be sure to keep the new password in mind.

6.2.2 Attention: Make sure the new password is in 6 digits Arabic numbers, or the tracker cannot recognize the password.

6.2.3 When reading this user manual, you will notice that we have used "+" and "space" between some words; "+" between two words means they should be written together as one word and "space" between two words means you should leave one character space between two words.

6.3 Authorization

6.3.1. You must setup the authorized phone number before using GEO-fence alarm etc. Up to 5 numbers can be authorized.

6.3.2. Call the tracker for 10 times continuously and get its position, then it will save the cell phone number as the authorized number automatically. and reply “add master ok”.

6.3.3. Authorization: Send SMS “admin+password+space+cell phone number” to set up an authorized number, the other authorized numbers should be set by the first authorized number, if the number is successfully authorized, the unit will reply “ admin OK” by SMS.

6.3.4. Delete authorization: Send SMS “noadmin+password+space+authorized number” to delete the authorized number.

6.3.5. If you want to track the target when it enters into another country, you must add the country code before the cell phone number. You should authorize your number in international format as follows: “admin123456 008613322221111” to tracker to set 13322221111 as an authorized number.

6.4 Single Locating

6.4.1. If there aren't any authorized number set-up, it will reply all calls with a location report; if there are authorized numbers set-up, then it will not respond when an unauthorized number calls it.

6.4.2. If you call it from authorized phone number, it will hang up and report a real-time location as below:



6.4.3. When lost fix to satellites, it will track by LBS / CELL-ID. And the SMS will include two parts:

- GPS coordinates of the last known position.
- LAC code.

6.5 Auto track continuously

6.5.1 Track with limited times upon time interval

Send SMS command “fix030s005n +password” to the tracker device, it will report the latitude & longitude at intervals of 30 seconds for 5 times. (s:second, m:minute, h:hour). This command set must be in 3 digits Arabic numbers and the maximum value is 255.

e.g. fix030s005n123456

6.5.2 Track with unlimited times upon time interval

Send SMS “fix030s030m***n+password” to the tracker. Tracker will report a real-time location every 30 seconds when ACC is ON, and report every 30 minutes when ACC is OFF.

Note: The interval must not less than 10s.

6.5.3 Track upon distance interval

Send SMS: “Distance+password+space+distance” , Tracker will reply “Distance ok” , and then tracker will locate upon the pre-set distance.

Eg: Send SMS:Distance123456 0050” it means distance is 50 meters; the number must be 4 digits Arabic numbers.

6.5.4 Smart track upon time and distance interval

6.5.4.1. Send SMS:“ fix030s600s***n+password+space+distance” to tracker .The distance unit is meter.

Eg: send SMS “fix030s600s***n123456 0200” means: ACC off ,Tracker will report a real-time location every 600 seconds ; ACC ON, Tracker will report a real-time location every 30 seconds or moving distance is up to 200 meters .

6.5.4.2. Cancel: Send SMS “nofix+password” to the tracker device

6.6 Data logging and upload

- 6.6.1. Auto logging and upload: When the tracker device lost GSM signals or fall offline from GPRS, tracker will log the tracking position and alerts automatically on the basis of the pre-set condition, when GPRS is normal, all the data will be auto-sent to web platform (server).
- 6.6.2. Logging upon times: Send SMS: "save030s005n+password" to the tracker unit, it will reply "save ok", and will log the Latitude and longitude locations every 30 seconds for 5 times. (S: second, m: minute; h: hour).
- 6.6.3. Multi-logging: Send SMS: "save030s***n+password" to tracker device, it will reply "save ok".
- 6.6.4. Cancel logging: Send SMS "nosave+password", e.g. nosave123456
- 6.6.5. Logging Clearance: send SMS: "clear+password" to tracker device, it will reply "clear ok".

6.7 Exact street address

- 6.7.1. You must set up the APN of your local GSM network for the SIM card in tracker first before using this function, if your local need user name and password for GPRS login, Pls set (refer to 6.20 section of this manual to configure the APN, user name and password for GPRS login).
- 6.7.2. After configure the APN, send "address+password" to device, it will reply SMS including real street/address name. For example: No.113, Guankou 2nd Rd, Nantou, Nanshan district, Shenzhen, Guangdong, china.

6.8 Forward the third parties' message

- 6.8.1. Send SMS "forward+password+space+third parties' phone number" from authorized phone number, tracker will reply "forward ok", and supports 1 third parties' phone numbers at most.
- 6.8.2. For example, you can set the phone number of the service provider of the SIM card in

the tracker, when charge remind message coming in, tracker will forward it to authorized phone number.

6.8.3. Cancel: Send SMS command "noforward+password".

6.9 SIM card Balance Inquiry

6.9.1. Send SMS command "balance+password+space+carrier's phone number+space+code" to tracker, it will forward the code to carrier's phone number and return the balance message received from carrier's phone number.

6.9.2. How it works: Take china mobile for example, After accept balance command, tracker will remember the "mobile phone number", carrier's phone number and the code;

6.9.3. And then send the code to carrier's phone number, and forward the message from carrier to mobile phone number.

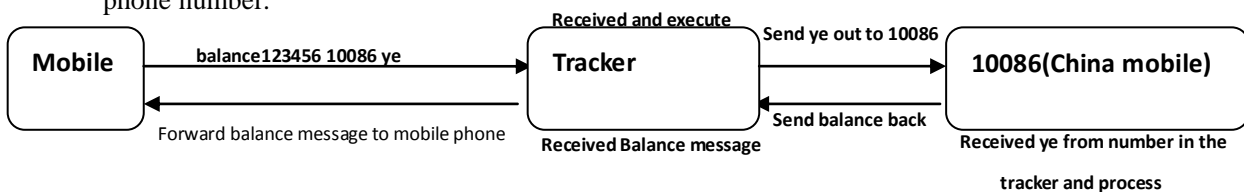

6.10 ACC working alarm

6.10.1. This function is deactivated by default. send SMS command "ACC+password" to tracker to activate it, tracker will reply "ACC ok". And tracker will send "ACC on+latitude & longitude" to authorized numbers when detect ignition on, that means the vehicle has been started; and tracker will send "ACC off+latitude & longitude" to authorized numbers when ignition off and ACC is off, that means vehicles has been stopped.

6.10.2. Send "noACC+password" to deactivate this function, tracker will reply "noACC ok".

6.10.3. This configuration can only activate and deactivate the alarm to authorized numbers; it will send to web platform automatically in GPRS mode and can't be deactivated.

6.11 Cut off the Oil and Power System (For B,C model)

6.11.1. Stop mode.

6.11.1.1. Execute immediately: Send command “quickstop+password” to tracker, it will reply “quickstop OK”. Then tracker will stop the car immediately after “stop” command.







6.11.1.2. Execute depends on speed(Default mode): Send command “noquickstop+password” to tracker, It will reply “noquickstop OK”, Then the tracker won’t stop the car immediately after “stop” command, instead, it will reply “it will be executed after speed less than 20KM/H”, and stop the car when the speed is less than 20KM/H.

6.11.2. Send command “stop+password” to tracker, tracker will execute it and reply “Stop engine Succeed”. And it will remain immobile state until next command to resume.

6.11.3. Resume the Oil and Power System

Send “resume+password” to tracker, it will reply "Resume engine succeed", it means the oil supply is resumed.

6.12 Remote controller (For C model)

Button	Function	Descriptions
	ARM	Press for 0.5 second, the siren will beep one time.
	DISARM	Press for 0.5 second, the siren will beep two times.
	ARM & Silent mode	Press for 0.5 second when it is in disarm state, the siren will beep one times. No voice from siren when alarm triggered and quit from silent mode automatically when disarm.
	SOS	Press for 3 seconds, Tracker will send SOS alert to authorized phone numbers without voice.
	Deterrence/car search	Press for 0.5 second when it is in arm state, siren will beep 10 seconds, press disarm button  to quit.

6.12.1. ARM

Press  button on the remote controller for 0.5 seconds, the car enters into armed state and the siren will beep one time. If the car is in ignition (ACC is at “ON” position), then the car can’t enter ARM state, and siren keep silent.

6.12.2. Set up silent mode

Press  in disarm state for 0.5 second, the siren will beep one time, the car will enter ARM & Silent mode. Siren won’t be sound after alarm is triggered, but tracker will send alarm SMS to authorized numbers.

6.12.3. DISARM

Press  on remote controller for 0.5 seconds, the car will enter DISARM state and,

siren beeps two times and tracker doesn't send message.

6.13 Set up arm/disarm by SMS

6.13.1. ARM

Send "arm+password" to tracker, it will make the car enter ARM states and and reply "Tracker is activated".

If the car is in ignition (ACC is at "ON" position), then the car can't enter ARM state, reply "set up fail! pls turn off ACC".

6.13.2. Silent Mode

Send "silent+password" to tracker, it will reply "silent ok!" that means tracker enters ARM & silent mode, Siren won't be sound after alarm is triggered, but tracker will send alarm SMS to authorized number.

Send "disarm+password" to quit ARM & silent mode.

6.13.3. DISARM

Send command "disarm+password" to tracker, tracker will disarm and reply "Tracker is deactivated", and then it will turn off the alarm of shock sensor and ACC.

6.14 Decide how many times of alarm message

You can decide how many times of the alarm message to be sent, For those alarm message sent in cycle, you can limit the times the alarm message to be sent. Send SMS "xtime+password+005" to tracker, alarm message will be sent 5 times once alarms are triggered.

The Alarm SMS will be sent 5 times by default.

6.15 Alarms

6.15.1 Low battery alarm

Send SMS "lowbattery+password+space+on", it will send SMS "low battery+latitude/longitude" to authorized numbers 2 times in total **in 15 minutes interval** when voltage of battery is going to be about 3.55V.

This function activates by default, send SMS "lowbattery+password+space+off" to deactivate.

6.15.2 Power off alarm

This function activates by default.

Send “ extpower+password+space+on” to activate, it will send SMS “power alarm+latitude/longitude” to authorized numbers every 3 minutes when external power is cut off.

Cancel: Send SMS “ extpower+password+space+off” to deactivate it.

6.15.3 Geo-fence

Set up a geo-fence for the tracker device to restrict its movements within a district. The unit will send SMS to the authorized numbers when it goes out of this district.

Set up: When the unit stays immobile in a place for 3-10 minutes, the user can send SMS “stockade+password+space+latitude,longitude;latitude,longitude” to unit to set the restricted district. In case of breach, it will send SMS “stockade!+ latitude & longitude” to the authorized numbers.

Remark: The first latitude & longitude is coordinate of the top left corner of the Geo-fence, while the second latitude & longitude is the coordinate of the bottom right corner, it will send alarm SMS at interval of 3 minutes once beyond the restricted district.

Cancel: Send SMS “nostockade+password” to deactivate this function.

6.15.4 Movement alarm

Set up: when the unit stays immobile in a place for 3-10 minutes with GPS signal reception, the user can send SMS “move+password+space+0200” to the tracker (Suppose area of a radius of 200 meters, it supports 4 digits at most. Unit: Meter). It will reply “move OK”. In case of such a movement (the default distance is 200m), it will send SMS “Move+ latitude & longitude” to the authorized numbers.

Cancel: Send SMS “nomove+password” to deactivate the movement alarm

6.15.5 Over speed alarm

Set up: Send SMS “speed+password+space+080” to the unit (suppose the speed is 80km/h), and it will reply “speed OK!”. When the target moves exceeding 80km/h, the unit will send SMS “speed+080!+ latitude & longitude” to the authorized numbers , **it will only send one SMS in 3 minutes in SMS mode when overspeed ; the siren will beep 1 time when overspeed 1 time.**

Cancel: Send SMS “nospeed+password” to deactivate the overspeed alarm.

Remark: The recommended speed should be not less than 30km/h. For below that rate, it will be effected the accuracy by GPS signals drift etc.

6.15.6 ACC Alarm

The unit will send SMS “ACC alarm+lat/long” to the authorized number at interval of 3 minutes when the engine of the car is turned on, that is the key is rotated to “ACC ON” position to start the car in arm state; Siren will be sound for 20 seconds, and repeat again at interval of 20 seconds if the ACC always keep ON.

Disarm to stop this alarm

6.15.7 Built in Acceleration Sensor Alarm

6.15.7.1. There is a built-in three axis acceleration sensor in the tracker; so the tracker can detect its status in arm state when the vehicle moves, tilt or shock. Disarm to stop this alarm.

6.15.7.2. Built-in Shock sensor sensitivity configuration

The sensitivity of the built-in shock sensor has three different levels:

First level: Alarm will be triggered after detect slight vibration, send command " sensitivity+password+space+1" .

Second level: Alarm will be triggered after detect 8 times vibration in 2 seconds, send command " sensitivity+password+space+2".

Third level: Alarm will be triggered after detect 25 times vibration in 5 seconds, send command " sensitivity+password+space+3".

6.16 Sleep Mode

Sleep mode	Description	Application Occasions
Always online	GPRS is real-time online, you can configure different time intervals depends on moving or motionless status.	Track the real-time movements of the target.
Sleep	GPRS will be offline if it is motionless, vibration, calling can wake up the tracker, GPRS will be online if target is moving.	Sleep if the target is motionless, and track when the target start to move.

6.16.1 Always online

Send SMS command”sleep+password+space+off” to tracker device , tracker will reply”sleep off ok”. Tracker GSM, GPS, LED will always work without sleep .This mode is the default mode.

6.16.2 Sleep Mode

This function is deactivated by default, send “sleep+password+space+on”, tracker

will reply “sleep on ok”. When vehicle is not driving (ACC is OFF), GSM module fall asleep; GPS module shut off; and tracker works in low power consumption. Calling, SMS command, ACC and any triggered alarm can awake it.

6.17 Check the Vehicle State

Send SMS command “check+password” to the tracker in the vehicle, It will reply SMS includes power, battery, GPS signal, ACC, GSM signal, GPRS state, APN, UP, IP, PORT and so on.

For example, if you send sms: check123456 to the tracker in the vehicle, it will reply SMS as follows:

Power: ON/OFF

Battery: 100%

GPS: OK/NO GPS

ACC: OFF/ON

GSM Signal: 1-32 Note: The higher digit it shows; the better.

GPRS: ON/OFF

APN: cmnet

IP: 104.250.138.146

PORT: 9000

6.18 Check IMEI

Send SMS command "imei+password" to the device. E.g: Send SMS command "imei123456" to the tracker device, it will reply an IMEI number in 15 digits to your cell phone.

6.19 Terminal (local) Time Setting

Send SMS command “time+space+zone+password+space+time” to the device, If succeed, it will reply “time OK”. For example: Send SMS “time zone123456 8”, 8 is Chinese time zone, If your country time zone is minus, send SMS “time zone123456 -8”.

6.20 GPRS settings

User must send SMS via cell phone to set up IP, port and APN before starting GPRS.

6.20.1 Configure APN

APN standards for Access Point Name and differs from country to country. For more information about your local APN, please inquire with your local GPRS network operator.

Send SMS command to tracker “APN+password+Space+your local APN” via a cell phone and if executed, the tracker will reply “APN OK”.

For example: Send SMS command “APN123456 CMNET”. If executed, the tracker will reply “APN OK”.

Notes: 123456 refer to password of tracker and CMNET is the APN of Network Operator of china (China mobile).

6.20.2 Configure user, password for GPRS login

In most countries, the user name and password involving GPRS login are not compulsorily necessary, therefore, the entry can be skipped. For those countries requiring user name and password, please configure as following:

Send SMS “up+password+space+user+space+password”, if executed, tracker will reply “user, password ok!”, for example: send SMS “up123456 jonnes 666666”

Note: 123456 is password of tracker, jonnes is the user name for GPRS login, 666666 is the password for GPRS login.

6.20.3 Configure IP and port

Send SMS “adminip+password+space+IP+space+port”, tracker will reply “adminip ok” if executed.

For example: send SMS “adminip123456 104.250.138.146 9000”, tracker will reply “adminip ok” if executed. (123456 is the password of tracker, and 104.250.138.146 is the ip, 9000 is the port.)

6.20.4 Switch to GPRS mode

6.20.4.1. Send SMS command “GPRS+password” to tracker, it will reply “GPRS ok!”, that means tracker have switched to work in GPRS mode.

6.20.4.2. TCP/UDP Switch

SMS command: “GPRS+password,0,0” is used to switch to TCP mode, TCP is the default mode.

SMS command: “GPRS+password,1,1” is used to switch to UDP mode.

6.20.4.3. Send SMS command: “SMS+password” to tracker, it will reply “SMS OK!”, and switch back to SMS mode

6.21 Configure parameters by USB

Connect tracker to computer with Micro USB cable, open the memory of the tracker, find and open the initial configuration file  user_config.ini with notepad, operate according to the instructions.

Note: The old password field must be filled every time when you want to change any settings.

7. Cautions

Please comply with the instructions to extend the unit life:

1. Keep the unit dry. Any liquid, i.e. rain, moisture, may destroy or damage the inside circuitry.
2. Don't use & store the unit in dusty places.
3. Don't put the unit in overheated or overcooled places.
4. Handle carefully. Don't vibrate or shake it violently.
5. Clear the unit with a piece of dry cloth. Don't clean in chemicals, detergent.
6. Don't paint the unit, this may cause some foreign materials left in between the parts.
7. Don't disassemble or refit the unit.
8. Please read the user manual carefully before installation and operation, learn something more about the voltage range. Otherwise, it won't work properly or destroy the product.

8. Faults & the Solutions

Faults	Solution
Fail to turn it on	Please check if built-in battery is charged, and power wires connected well.
No GSM signal	<ul style="list-style-type: none"> ● Please check if SIM card installed correctly. ● Please check if SIM card is GSM network. ● Don't turn on the PIN code ● no calls can be diverted ● The voltage of power supply is normal?
No GPS	Installed location should be unblocked to ensure to receive GPS signals.
No reply to SMS command	Password wrong or the SMS format is wrong
Call without SMS reply or cannot receive alarm SMS	Authorized number is wrong or didn't configure any authorized numbers

Stop engine fail	Check the relay for engine cut is right connected.
Remote Controller fail	Remove external power , turn on the device and program again
Siren fail	Negative trigger siren, the other wires of siren need to be connected to corresponding power (+).